

## ■ 特徵

- 引動器種類廣泛，且有動作位置可調整之設計(如TM1701)
- 高開閉容量(15A)
- 高精確度
- 廣泛操作速度範圍

## ■ 規格

- 額定值

額定電壓	非電感性負載(A)				電感性負載(A)				突入電流(A)	
	電阻性負載		燈泡負載		電感性負載		馬達負載			
	NC	NO	NC	NO	NC	NO	NC	NO	NC	NO
125 VAC	15	3	1.5	1.25	15	5	2.5		30	15
250 VAC	15	2.5	1.25	1.5	15	3	1.5			
500 VAC	3	1.5	0.75	2.5	1.5	0.75				
8 VDC	15	3	1.5		15	5	2.5		以下	以下
14 VDC	15	3	1.5	10	5	2.5				
30 VDC	6(2)	3	1.5	5	5	2.5				
125 VDC	0.4	0.4	0.4	0.05	0.05	0.05				
250 VDC	0.2	0.2	0.2	0.03	0.03	0.03				

- 特性

操作速度	0.01mm至1m/sec(柱塞型)
動作頻率	機械：240次/分 電氣：20次/分
接點電阻	15m Ω 以下(初期)
絕緣電阻	100MΩ 以上(在500VDC下)
耐電壓	非連續端子間 1,000VAC，50/60Hz持續1分鐘 載流零件與接地間 2,000VAC，50/60Hz持續1分鐘
振動	(* 10至20Hz)：1.5mm 雙振幅 誤動作耐久：10至55Hz
衝擊	機械耐久：約1,000m/Sec <sup>2</sup> (約100G'S) 誤動作耐久：約300m/sec <sup>2</sup> (約30G'S)
周圍使用溫度	汎用型：-25° 至 +80°C 密封型：-15° 至 +80°C
濕度	汎用型：85%RH以下 密封型：95%RH
使用壽命	機械：20,000,000次以上 電氣：500,000次以上
重量	約22至58g

## ■ 動作特性

型 式	TM 1300	TM 1301	TM 1303	TM 1305	TM 1306	TM 1307	TM 1308	TM 1309
OF 最大	350 g	300 g	300 g	350 g	350 g	350 g	350 g	350 g
RF 最小	114 g	50 g	50 g	114 g	114 g	114 g	114 g	114 g
PT 最大	0.4 mm	4 mm	4 mm	0.4 mm	0.4 mm	0.4 mm	0.4 mm	0.4 mm
OT 最小	0.13 mm	1.6 mm	1.6 mm	1.6 mm <td 1.6 mm	5.5 mm	3.58 mm	3.58 mm	
MD 最大	0.05 mm	1.3 mm	1.3 mm	0.05 mm	0.05 mm	0.05 mm	0.05 mm	0.05 mm
FP 最大		20.6 mm	31.8 mm					
OP	15.9 ± 0.4 mm	17.4 ± 0.8 mm	28.6 ± 0.8 mm	28.2 ± 0.5 mm	21.5 ± 0.5 mm	21.8 ± 0.8 mm	33.4 ± 1.2mm	33.4 ± 1.2 mm



- TM系列每一型式均具有焊接端子、螺絲端子與快速端子可供選擇
- 型號後面加A則為焊接端子，加C則為快速端子，空白則為螺絲端子

- 螺絲端子
- 焊接端子
- 快速端子

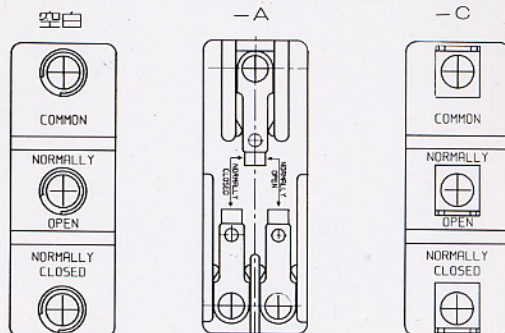

- 接點構成



- 動作特性

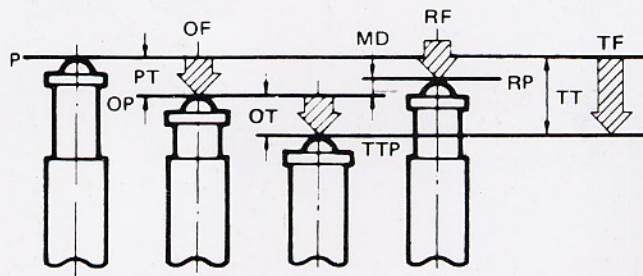

動作

回復

- OF: 動作所需之力
- RF: 回復力
- TF: 整個移動所需之力
- FP: 自由位置
- OP: 動作位置
- RP: 回復位置
- TTP: 整個移動之位置
- PT: 至動作為止之移動
- OT: 動作後之移動
- MD: 距差
- TT: 整個移動

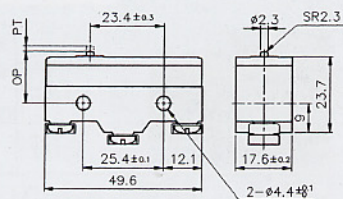
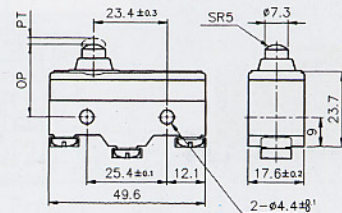
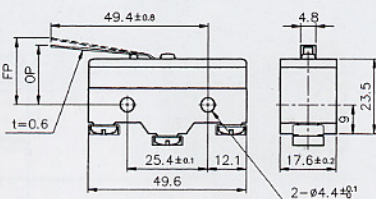
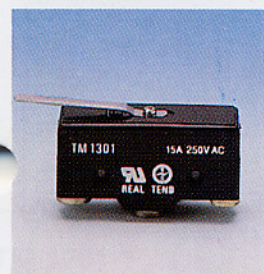
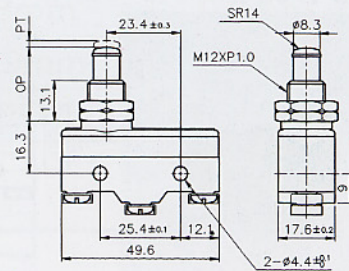
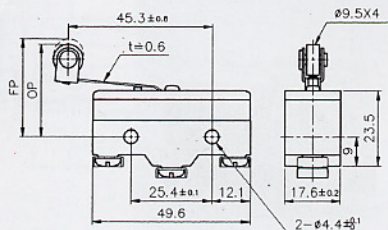
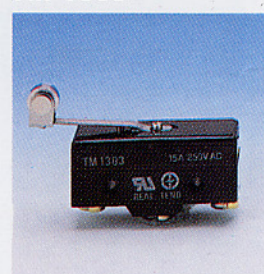
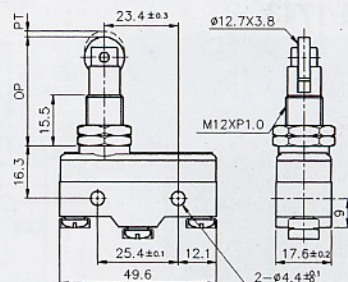
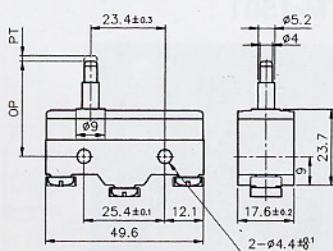
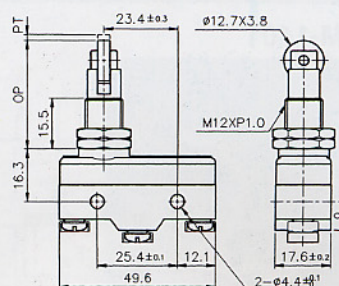
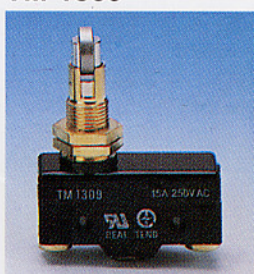

**■ 外觀和尺寸**
**TM-1300**

**TM-1306**

**TM-1301**

**TM-1307**

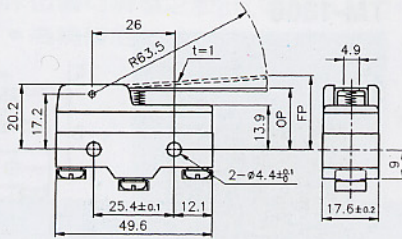
**TM-1303**

**TM-1308**

**TM-1305**

**TM-1309**

型 式	TM 1701	TM 1702	TM 1703	TM 1704	TM 1705	TM 1743	TM 1401	TM 1501
OF 最大	70 g	100 g	160 g	160 g	10 g	160 g	500 g	600 g
PF 最小	14 g	28 g	22 g	42 g	3 g	42 g	170 g	300 g
PT 最大	10 mm	5 mm	7.1 mm	2.7 mm	20 mm	2.7 mm	5 mm	3 mm
OT 最小	5.6 mm	2 mm	4 mm	2.4 mm	5.6 mm	2.4 mm	12.7 mm	6 mm
MD 最大	1.27 mm	1 mm	1.02 mm	0.5 mm	3 mm	0.5 mm	2.2 mm	2 mm
FP 最大	28.2 mm	24.8 mm	36.5 mm	32.5 mm		43.6 mm	44.5 ± 1.6 mm	41 ± 1.6 mm
OP	19 ± 0.8 mm	19 ± 0.4 mm	30.2 ± 0.8 mm	30.2 ± 0.4 mm	19 ± 0.4 mm	41.3 ± 0.8 mm	40.4 ± 1.6 mm	40.4 ± 1.6 mm



TM-1701



TM-1702

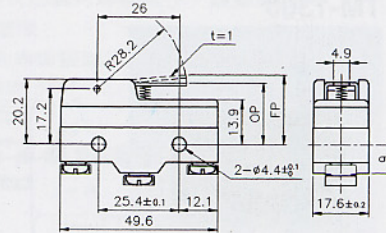

TM-1703

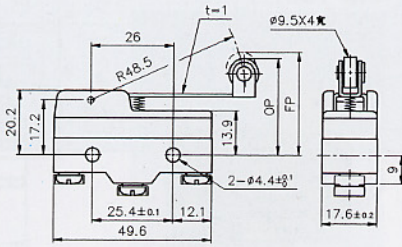
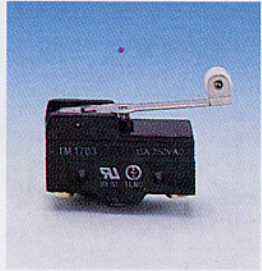

TM-1704

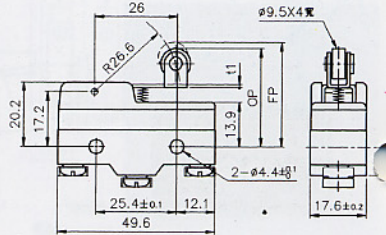

TM-1743

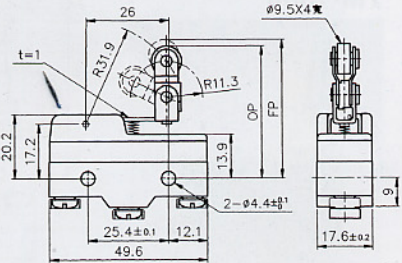

TM-1705

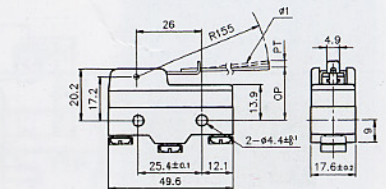
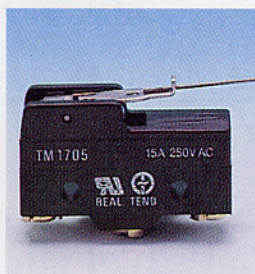

TM-1401

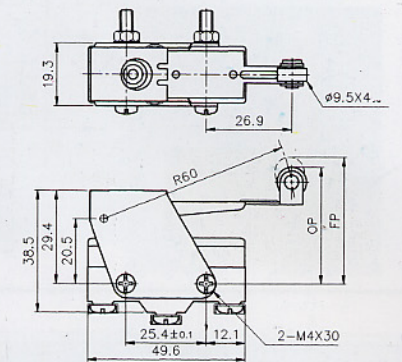
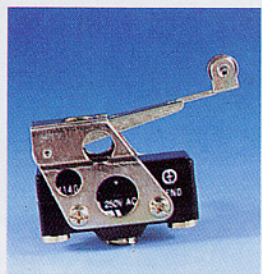

TM-1501

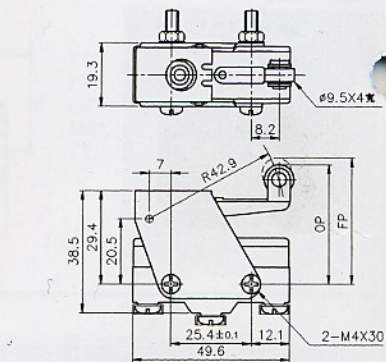

TAP-Y

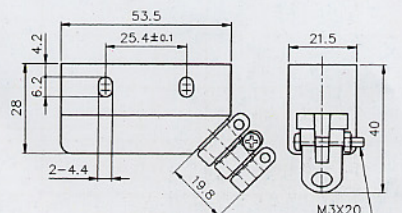

TAP-Z

